

COBY Electronics Corp.

56-65 Rust Street
Maspeth, NY 11378

www.cobyusa.com
www.ecoby.com

COBY®

DP860/862



**8" Widescreen Digital Photo
Frame with Multimedia Playback**

**DP860
DP862**

INSTRUCTION MANUAL

Please read this manual carefully before operation

PRECAUTIONS

	CAUTION WARNING: SHOCK HAZARD. DO NOT OPEN. AVIS: RISQUE DE CHOC ELECTRIQUE. NE PAS OUVRIR	
CAUTION: TO REDUCE THE RISK OF FIRE AND ELECTRIC SHOCK, DO NOT REMOVE THE COVER (OR BACK) OF THE UNIT. REFER SERVICING ONLY TO QUALIFIED SERVICE PERSONNEL.		



The lightning flash with arrowhead symbol within an equilateral triangle is intended to alert the user to the presence of uninsulated "dangerous voltage" within the product's enclosure that may be of sufficient magnitude to constitute a risk of electric shock.



The exclamation point within an equilateral triangle is intended to alert the user to the presence of important operation and servicing instructions in the literature accompanying the appliance.

For Customer Use:

Enter below the serial number that is located on the bottom of the unit. Retain this information for future reference.

Model No. _____ DP860/DP862 _____

Serial No. _____



For recycling or disposal information about this product, please contact your local authorities or the Electronics Industries Alliance: www.eiae.org.

PRECAUTIONS

WARNING:

To prevent fire or shock hazard, do not expose this device to rain or moisture. Dangerous high voltage is present inside the enclosure. Do not open the cabinet.

CAUTION: To prevent electric shock, match wide blade of plug to wide slot of outlet and fully insert.

Protect your hearing: Hearing experts advise against the constant use of personal stereos played at high volume. Constant exposure to high volumes can lead to hearing loss. If you should experience ringing in the ears or hearing loss, discontinue use and seek medical advice.

FCC Statement:

this device complies with Part 15 of the FCC Rules. Operation is subject to the following two conditions:

- (1) This device may not cause harmful interference, and
- (2) This device must accept any interference received, including interference that may cause undesired operation.

Note:

This equipment has been tested and found to comply with the limits for Class B digital devices, pursuant to Part 15 of the FCC rules. These limits are designed to provide reasonable protection against harmful interference in a residential installation. This equipment generates, uses and can radiate radio frequency energy and, if not installed and used in accordance with the instructions, may cause harmful interference to radio communications. However, there is no guarantee that interference will not occur in a particular installation. If this equipment does cause harmful interference to radio or television reception, which can be determined by turning the equipment off and on, the user is encouraged to try to correct the interference by one or more of the following measures:

- Reorient or relocate the receiving antenna.
- Increase the separation between the equipment and receiver.
- Connect the equipment into an outlet on a circuit different from that to which the receiver is connected.
- Consult the dealer or an experienced radio/TV technician for help

Use of shielded cable is required to comply with Class B limits in Subpart B of Part 15 of the FCC rules.

Do not make any changes or modifications to the equipment unless otherwise specified in the manual. If such changes or modifications should be made, you could be required to stop operation of the equipment.

IMPORTANT SAFETY INSTRUCTIONS

1. **Read Instructions:** All the safety and operating instructions should be read before the product is operated.
2. **Retain Instructions:** The safety and operating instructions should be retained for future reference.
3. **Heed Warnings:** All warnings on the product and in the operating instructions should be adhered to.
4. **Follow Instructions:** All operating and usage instructions should be followed.
5. **Cleaning:** Unplug this product from the wall outlet before cleaning. Do not use liquid cleaners or aerosol cleaners. Use a damp cloth for cleaning.
6. **Attachments:** Use only attachments recommended by the manufacturer. Use of other attachments may be hazardous.
7. **Water and Moisture:** Do not use this product near water (e.g., near a bath tub, washbowl, kitchen sink, laundry tub, in wet basements, or near a swimming pool and the like).
8. **Accessories:** Do not place this product on an unstable cart, stand, tripod, bracket, or table. Use only with carts, stands, tripods, brackets, or tables recommended by the manufacturer or sold with the product. Any mounting of the product should follow the manufacturer's instructions and should use a mounting accessory recommended by the manufacturer.
9. A product and cart combination should be moved with care. Quick stops, excessive force, and uneven surfaces may cause the product and cart combination to overturn.
10. **Ventilation:** Slots and openings in the cabinet are provided for ventilation to ensure reliable operation of the product and to protect it from overheating. These openings should never be blocked by placing the product on a bed, sofa, rug, or other similar surface. This product should not be placed in a built-in installation such as a bookcase or rack unless proper ventilation is provided or the manufacturer instructions have been adhered to.
11. **Power Sources:** This product should be operated only from the type of power source indicated on the rating label. If you are not sure of the type of power supply to your home, consult your product dealer or local power company. For products intended to operate from battery power or other sources, refer to the operating instructions.



IMPORTANT SAFETY INSTRUCTIONS

12. **Grounding or Polarization:** This product may be equipped with a polarized alternating-current line plug that has one blade wider than the other. This plug will only fit into the power outlet in one direction. This is a safety feature. If you are unable to insert the plug fully into the outlet, try reversing the direction of the plug. If the plug should still fail to fit, contact an electrician to replace the obsolete outlet. Do not defeat the safety purpose of the polarized plug.
13. **Power-Cord Protection:** Power supply cords should be routed so that they are not likely to be walked on or pinched by items placed upon or against them, paying particular attention to cords at plugs, convenience receptacles, and at the point which they exit from the product.
14. **Protective Attachment Plug:** The product may be equipped with an attachment plug with overload protection. This is a safety feature. See the operating instructions for replacement or directions to reset the protective device. If replacement of the plug is required, be sure the service technician has used a replacement plug that has the same overload protection as the original plug as specified by the manufacturer.
15. **Outdoor Antenna Grounding:** If an outside antenna is connected to the product, be sure the antenna system is grounded so as to provide some protection against voltage surges and built-up static charges. Article 810 of the National Electrical Code, ANS/NFPA 70 provides information with regard to proper grounding of the mast and supporting structure, grounding of the lead-in wire to an antenna-discharge unit, size of grounding conductors, location of antenna-discharge unit, connection to grounding electrodes, and requirements for the grounding electrode (see figure).

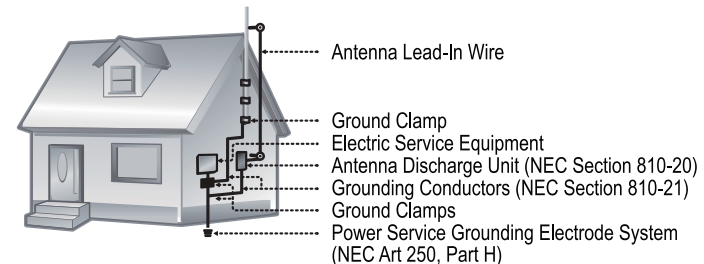

IMPORTANT SAFETY INSTRUCTIONS

16. **Lightning:** For added protection for this product, unplug it from the wall outlet and disconnect the antenna or cable system during a lightning storm or when it is left unattended and unused for long periods of time. This will prevent damage to the product due to lightning or power-line surges.
17. **Power Lines:** An outside antenna system should not be located in the vicinity of overhead power lines or other electric light or power circuits, or where it can fall into such power lines or circuits. When installing an outside antenna system, extreme care should be taken to keep from touching such power lines or circuits, as contact with them might be fatal.
18. **Overloading:** Do not overload wall outlets, extension cords, or integral convenience receptacles as this can result in a risk of fire or electric shock.
19. **Object and Liquid Entry:** Never push objects of any kind into this product through openings as they may touch dangerous voltage points or short-out parts that could result in a fire or electric shock. Never spill liquid of any kind on the product.
20. **Servicing:** Do not attempt to service this product yourself as opening or removing covers may expose you to dangerous voltage or other hazards. Refer all servicing to qualified service personnel.
21. **Damage Requiring Service:** Unplug this product from the wall outlet and refer servicing to qualified service personnel under the following conditions: a) when the power-supply or plug is damaged; b) if liquid has been spilled or if objects have fallen into the product; c) if the product has been exposed to rain or water; d) if the product does not operate normally by following the operating instructions as improper adjustment of other controls may result in damage and will often require extensive work by a qualified technician to restore the product to its normal operation; e) if the product has been dropped or damaged in any way; f) when the product exhibits a distinct change in performance—this indicates a need for service.
22. **Replacement Parts:** When replacement parts are required, be sure that your service technician has used replacement parts specified by the manufacturer or have the same characteristics as the original part. Unauthorized substitutions may result in fire, electric shock, or other hazards.
23. **Safety Check:** Upon completion of any service or repairs to this product, ask the service technician to perform safety checks to ensure that the product is in proper operating condition.

IMPORTANT SAFETY INSTRUCTIONS

24. **Wall or Ceiling Mounting:** The product should be mounted to a wall or ceiling only as recommended by the manufacturer.
25. **Heat:** The product should be situated away from heat sources such as radiators, heat registers, stoves, or other products (including amplifiers) that produce heat.

TABLE OF CONTENTS

PRECAUTIONS	2
IMPORTANT SAFETY INSTRUCTIONS	4
TABLE OF CONTENTS	8
PACKAGE CONTENTS	10
FEATURES	11
LOCATION OF CONTROLS	12
Top View	12
Left View	13
Right View	13
Front View	13
Rear View	13
Remote Control	13
GETTING STARTED	14
Using the Remote Control.....	14
Installing a Memory Card.....	15
Powering your Digital Picture Frame.....	15
Turning Your Photo Frame On/Off.....	16
Menu Interface Navigation.....	16
Computer Connection (USB)	16
Connecting to a Computer	16
Main Menu Screen	17
SLIDESHOW MODE	18
Slideshow	18
PHOTO MODE	19
Photo Mode Screen	19
Photo View	20
Zoom	20
Rotation	20
Changing View	20
MOVIE MODE	21
Video List Screen	21
Video Controls	22
MUSIC MODE	23
Music List	23
Music Playback Screen	24
Music Controls	24

TABLE OF CONTENTS

CALENDAR	25
Date & Clock Screen	25
FILE MANAGER	26
File List	26
Deleting / Copying a File.....	26
SETUP MENU	27
System Setup.....	27
Photo Setup	28
Calendar Setup	28
Video Setup	29
Music Setup	29
CABLE CONNECTION	30
Headphones	30
KICKSTAND	31
FIRMWARE UPGRADES	32
TROUBLESHOOTING	33
SPECIFICATIONS	35

PACKAGE CONTENTS

Please make sure that the items shown below are included in the package. Should an item be missing, please contact the local retailer from which you purchased this product.

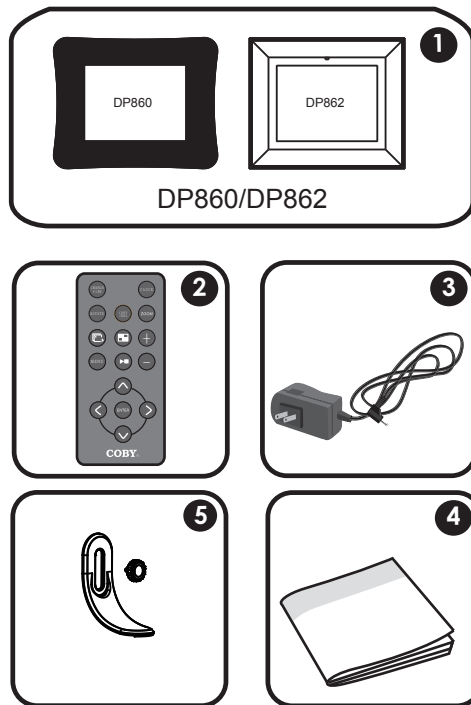

1. DP Frame x 1
(DP860/DP862)
2. Remote Control x 1

3. AC Adapter x 1
4. Manual x 1
5. Kickstand and Screw x 1

FEATURES

- 8" widescreen TFT LCD color display
- Displays JPEG, BMP and JPG photo files
- Plays MP3, WMA, OGG, ADPCM-WAV and PCM-WAV music files
- Plays AVI, MOV, MP4, 3GP video files, support MJPEG, MPEG-4, H264 video formats.
- Photo slideshow mode with music
- Calendar and clock with alarm timer
- SD, MMC, MS, xD, and CF card slots
- Full-size USB port for use with flash memory drives
- Integrated speaker
- Full-function remote control included
- Wall-mountable design with detachable stand

LOCATION OF CONTROLS

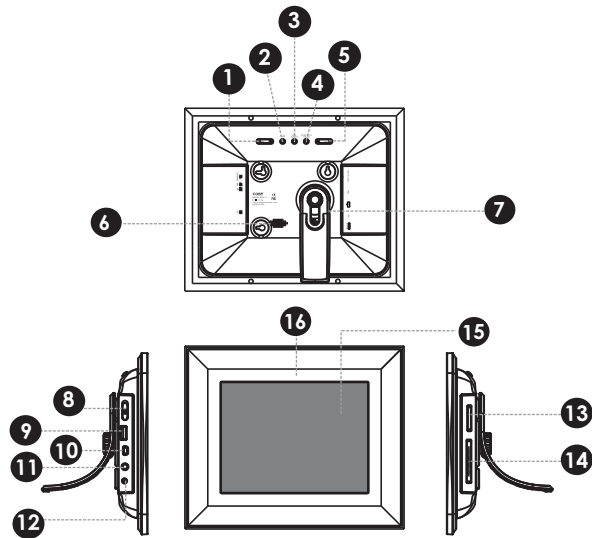

REAR VIEW

1. VOL -

- Press for left in Photo Thumbnail Mode.
- To turn down the volume level in Music, Video and Photo / Slideshow mode.
- In File Manager Mode: press this button to access the " Copy to internal memory? " dialogue box, select and confirm Yes to start copying.

VOL +

- Press for right in Photo Thumbnail Mode.
- To turn up the volume level in Music, Video and Slideshow Mode.
- In File Manager Mode: press this button to access the " Delete files ? " dialogue box, select and confirm Yes to delete.

2. Enter / Slideshow

- Press for enter during menu selection.
- Press this button to play/pause music / video.
- Press this button to pause the background music in photo (full-screen)

display mode/ slideshow mode, press again to resume the music.

- In photo (full-screen) display mode, press and hold this button to start / stop photo slideshow.

3. Change View

- Press this button to shift between the view modes Crop to Fill, Full Screen and Fit to Screen in photo (full-screen) display mode.
- Press this button to shift between the five display modes in calendar mode.

4. Menu

- Press for exit.
- On the Main Menu Screen, press this button to move the cursor to the memory device list.

5. Down

- Press for down during menu selection.
- On the Main Menu Screen, select the desired memory device, and then press the ENTER button to confirm.
- Press this button to fast-reverse through

the current track during music/video playback, press again for normal playback.

- Press this button to view the previous image in photo / slideshow mode.

Up

- Press for up during menu selection.
- On the Main Menu Screen, select the desired memory device, and then press the ENTER button to confirm.
- Press this button to fast-forward through the current track during music/video playback, press again for normal playback.
- Press this button to view next image in photo / slideshow mode.

6. Detachable Kickstand

7. Speaker and Ventilation Slots

LOCATION OF CONTROLS

LEFT VIEW

- 8. Power switch
- 9. USB Full-Size (For use with USB flash drives)
- 10. USB-Mini (for PC connection)
- 11. Headphone / Earphone Jack
- 12. Power in Jack

RIGHT VIEW (CARD SLOTS)

- 13. Secure Digital (SD) / Multi Media Card (MMC) / Memory Stick (MS) / XD-Picture (XD)
- 14. Compact Flash (CF)

FRONT VIEW

- 15. 8" TFT LCD Screen
- 16. Remote Sensor

Remote Control

- CHANGE VIEW
- ROTATE
- SLIDESHOW
- MENU
- PLAY / PAUSE
- UP ▲
- LEFT ◀
- DOWN ▼
- RIGHT ▶
- ENTER
- CLOCK
- COPY / DELETE
- ZOOM
- THUMBNAIL
- VOL +
- VOL -

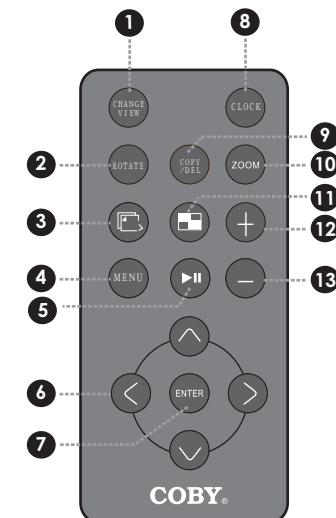

GETTING STARTED

Using the Remote Control

To load a battery in the remote:

1. Pull in the direction of the arrow
2. Slide the compartment out
3. Place the battery in the compartment with the positive side (+) facing up
4. Push the compartment in to close

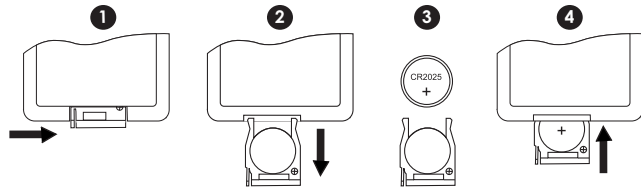

To use the remote:

- Point the remote at the remote sensor of the photo frame at a distance of no more than 15 feet (15") and at an angle no greater than 60 degrees.
- Batteries will last for about one year under typical usage. Replace the batteries if the remote is no longer working.
- Do not spill water on the remote control.
- Do not use the remote control for other equipment at the same time.
- Remove the batteries if the remote control will not be in use for an extended period of time.



The battery used in this device may present a fire or chemical hazard if mistreated. Do not recharge, disassemble, incinerate, or heat the batteries.

Used batteries should be disposed of safely and not incinerated. Attention should be shown to the environmental aspects of battery disposal.

Keep batteries out of the reach of children.

GETTING STARTED

Installing a Memory Card

Your picture frame supports the following types of memory cards:

- Memory Stick (MS)
- Compact Flash (CF)
- XD-Picture (XD)
- Secure Digital (SD)
- Multi Media Card (MMC)
- USB Flash Storage Drive

Simply insert the memory card of your choice into its corresponding card slot located on the left panel of the photo frame. Take care to orient the card in the proper direction.

Getting photos and files onto your picture frame for viewing couldn't be easier!

Powering your Digital Picture Frame

Your Picture Frame should be connected to an AC 100-240V wall outlet.

- Using the supplied power adapter, plug one end of the adapter into your photo frame's Power In jack and plug the other end into an AC 100-240V wall outlet.

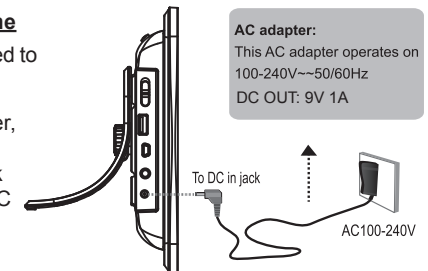

Do not connect the power plug to a power outlet other than that which is indicated here or on the label as this may result in the risk of fire or electric shock.

Do not handle the power plug with wet hands. Doing so may cause electric shock.

Use only AC adapters of the type specified here. Failure to do so may cause a fire or damage the player.

GETTING STARTED

Turning Your Photo Frame On/Off

- To turn your photo frame on, set the Power Switch to the “On” position.
- To turn your photo frame off, set the Power Switch to the “Off” position.

Menu Interface Navigation

To select the different menu options and files of your digital photo frame:

- Use the Navigation keys to make a selection.
 - To move the selection up, press ▲
 - To move the selection down, press ▼
 - To move the selection left, press ◀
 - To move the selection right, press ▶
 - **Press ENTER to confirm the highlighted selection.**
- To return to the previous screen, press MENU.

Computer Connection (USB)

Connect the DP frame to a computer with a USB cable to:

- Transfer files to and from your photo frame's installed memory cards.
- Perform basic file management functions.

Connecting to a Computer

Connect the photo frame to your computer with a USB cable. Upon connection:

- Your computer will automatically recognize the memory cards installed in your photo frame. Icons representing your installed memory cards will appear as “Removable Disk” when you open “My Computer”.

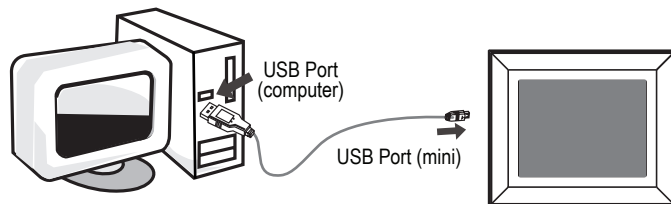

⚠ *Make sure that there's no USB flash drive connecting to the DP frame before connecting the DP frame to a computer.*

GETTING STARTED

Main Menu Screen

Upon turning on the power, your photo frame will display the “Main Menu” screen shown below.

- Press the MENU button and then press the UP/DOWN button to select an available card slot.

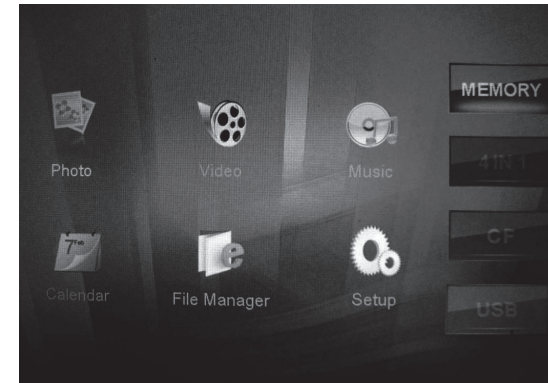

MAIN MENU SCREEN

Inserted: A card icon that is in-color indicates that a memory card has been inserted (installed) in the corresponding slot.

No Card: A card icon that is grayed-out indicates that a memory card has not been installed in the corresponding slot and is not available for use.

Selected:

- A highlighted frame indicates that the card slot is selected. Only card slots with an installed memory card may be selected.
- Highlighted: the Video icon is being selected.

Memory: Built-in Memory **4 IN 1:** SD / MMC / MS / XD Card

CF: CF card

USB: USB flash drive

You can save pictures on the Memory (built-in memory) and enjoy them as a demo slideshow. see File Manager section for operation details.

The demo slideshow will automatically start in approximately 8 seconds if there is no card inserted.

The demo slideshow will stop when a card is inserted or any button is pressed.

SLIDESHOW MODE

Slideshow

To display your photographs as a slideshow, press the SLIDESHOW  button at any time.

- To pause / resume background music during the slideshow, press the ENTER button.
- To play the next / previous track, press the UP or DOWN button.
- To adjust the volume level, press the VOL- or VOL+ button.
- To stop the slideshow, press the SLIDESHOW  button, press it again to resume.
- To exit, press the MENU button.

PHOTO MODE

Press the Thumbnail button or select the PHOTO icon on the Main Menu screen and press the ENTER button to enter the Photo Mode shown below:

(Make sure that the Display Mode is set to Thumbnail in Photo Setup, See SETUP section.)

PHOTO MODE SCREEN

- To display a photo (full screen), use the direction buttons to select a thumbnail and press the ENTER button to confirm.



1. An image file is being selected.
2. Information of the Selected image file.
3. Current Memory Device



*The Photo List will display supported Photo files, only.
Your photo frame can display baseline JPEG / JPG / BMP files.*

PHOTO MODE

Photo View

Select a thumbnail from the Photo Mode screen and press the ENTER button to display the photo in full-screen.

- To view the previous photo, press the LEFT button (or the UP button on the DP frame).
- To view the next photo, press the RIGHT button (or the DOWN button on the DP frame).
- To change the background music press the UP / DOWN button on the remote control.
- To rotate the photo, press the ROTATE button.

Zoom

To change the level of magnification, press ZOOM.

- Each successive press of ZOOM will change the level of magnification as shown below:

125% ➔ 150% ➔ 175% ➔ 200% ➔ 225% ➔ 250% ➔ ZOOM OFF

- To pan around the magnified picture, use the direction keys.
- During magnification, press the ENTER button for 100% display.

Rotation

To rotate the picture, press the Rotate button.

- Each successive press of ROTATE will change the degree of rotation as shown below:

Rotation 90° ➔ Rotation 180° ➔ Rotation 270° ➔ Rotation 0°

Changing View

Press the CHANGE VIEW button to change between the screen ratio modes Full Screen, Fit to Screen and Crop to Fill.

MOVIE MODE

To play your digital video files, select the Video icon from the Main Menu screen and press the ENTER button.

Video List Screen

Upon entering Video Mode, your photo frame will scan the memory device for available video files and display the "Video List" screen shown below. The Video List displays the filenames of all available video files.

- Use the direction keys to select a video file and press the ENTER button to start playback.

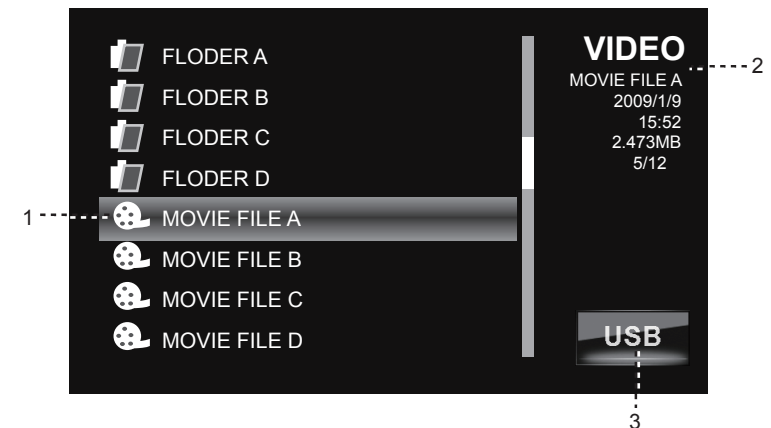

1. A video file is being selected.
2. Information of the selected File.
3. Current Memory Device



*The Video List will display supported Video files, only.
Your photo frame can play AVI, MOV, MP4, 3GP video files, support MPEG4, MJPEG, H264 video formats.*

MOVIE MODE

Video Controls

Use the DIRECTION keys to select a video file and press the ENTER button to start playback.

During playback:

- To pause playback, press the PLAY / PAUSE button. To resume playback, press it again.
- To adjust the volume level, press the VOL- or VOL+ button.
- To fast-forward through the current file, press the RIGHT button on the remote control (or the UP button on the DP frame).
- To fast-reverse through the current file, press the LEFT button on the remote control (or the DOWN button on the DP frame).
- Press the ENTER button for normal playback.
- To stop playback, press the MENU button.

MUSIC MODE

To play your digital audio files, select Music icon from the Main Menu screen and press the ENTER button.

Music List

Upon entering Music Mode, your photo frame will scan the memory device for available audio files and display the "Music List" screen shown below. The Music List displays the filenames of all available audio files.

- Use the direction keys to select an audio file and press the ENTER button to start playback.

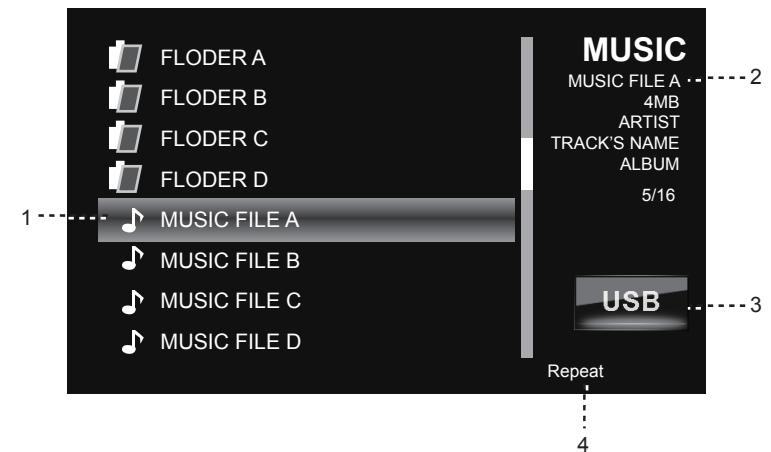

1. A music file is being selected.
2. Information of the selected File.
3. Current memory device.
4. Playback Mode (See SETUP section).



*The Music List will display supported audio files, only.
Your photo frame can play digital MP3, WMA and OGG audio files*

MUSIC MODE

Music Playback Screen

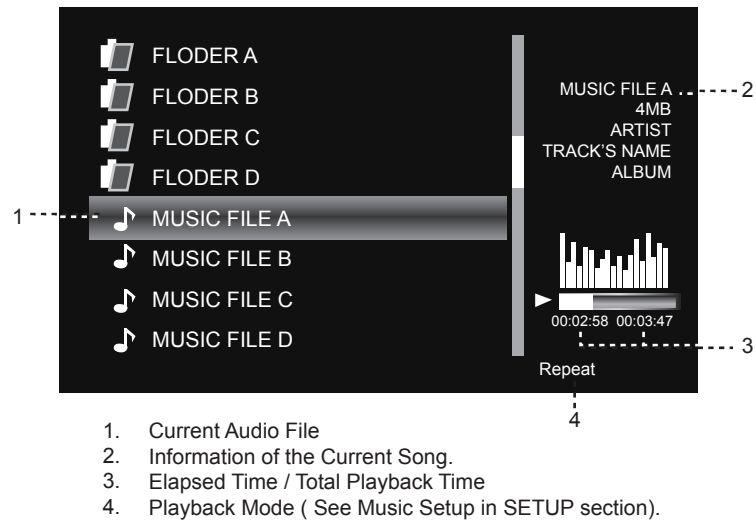

Music Controls

During playback:

- To pause playback, press the PLAY/PAUSE button. To resume playback, press it again.
- To fast-forward through the current file, press the RIGHT button on the remote control, press it again for normal playback. Or press and hold UP button on the main unit.
- To fast-reverse through the current file, press the LEFT button on the remote control, press it again for normal playback. Or press and hold DOWN button on the main unit.
- To play the next file, press the DOWN button to select and press the ENTER button to confirm.
- To play the previous file, press the UP button to select and press the ENTER button to confirm.
- To stop playback, press the MENU button.

CALENDAR

To view the time and date, press the CLOCK button on the remote control or select the Calendar icon from the Main Menu screen and press the ENTER button to access the Date & Clock Screen.

Date & Clock Screen

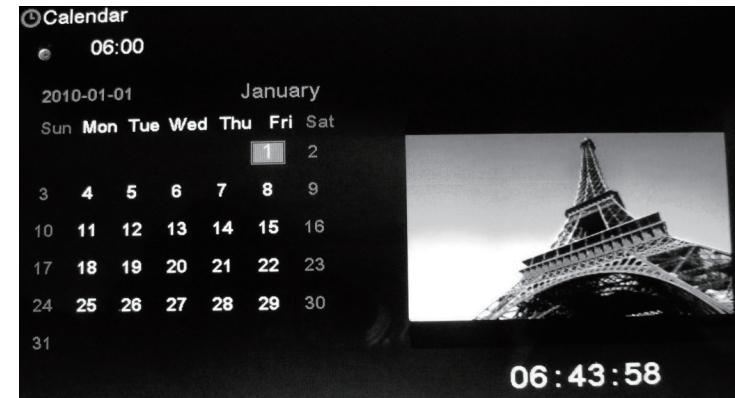

- Press the UP/DOWN button on the remote control to view the next / previous month.
- Press the ENTER button to pause the background music and the slideshow, press again to resume.
- Press the VOL+/VOL- to adjust the volume level.
- There're five Date & Clock display modes available, you can press the CHANGEVIEW button to select the desired one.



Details of operation for setting the time, date and alarm, see Calendar Setup in SETUP section.

FILE MANAGER

You can browse all supported digital files of the selected memory device and to delete files from the memory device or copy files from other memory devices to the built-in memory.

File List

Upon entering File Manager, your photo frame will scan the memory device for all available files and display the "File List" screen shown below.

- Use the navigation keys to select a file and press the ENTER button to view its information.
- Press the MENU button to exit.

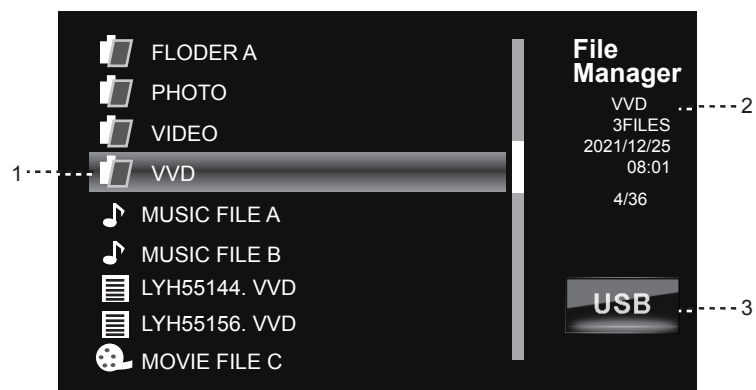

1. Selected Folder in the File List
2. Information of Selected Folder / File
3. Current Memory Device

Deleting / Copy a File

- To delete a file, select the unwanted file from the File List and press the COPY / DEL button to access the "COPY / DEL" dialogue box. Select DEL and then Confirm YES.
- To copy a file to the Memory (built-in memory), select the desired file from the File List and press the COPY / DEL button to access the "COPY/DEL" dialogue box. Select COPY and then confirm YES.
- Press the MENU button to exit.



Please refer to the Photo Mode, Music Mode, and Video Mode sections of this manual for playback controls

SETUP MENU

To adjust the settings and options of your digital photo frame, select SETUP from the Main Menu and press the ENTER button to confirm. The Setup Menu will be displayed on screen.

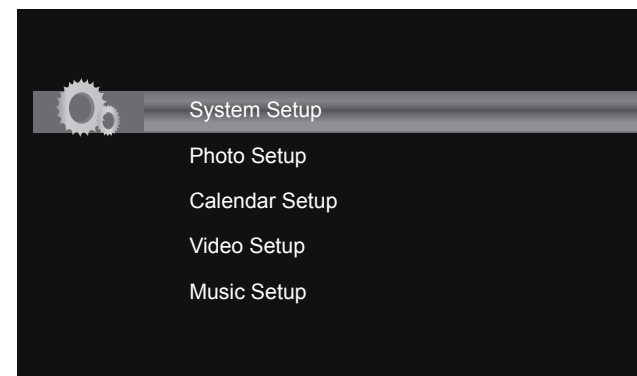

- Use the DOWN/UP keys to highlight and display an option / sub-menu.
- Press the RIGHT/LEFT button to select an option.
- To exit the Setup Menu, press the MENU button.

System Setup

Item	Instruction	Default setting
Brightness	Sets the brightness of the screen.	50
Backlight	Sets the backlight of the screen.	4
Contrast	Sets the Contrast of the screen.	50
Saturation	Sets the Saturation of the screen.	50
Hue	Sets the Hue of the screen.	50
Language	Sets the menu language of the player.	English
Auto-Power On	Sets the auto-power on/off time for the player.	
Auto-Power Off	1. Make sure the Power switch on the DP frame is set to ON. 2. Press the UP/DOWN button to select On / Off and time. 3. Press the LEFT/RIGHT button to select the desired time and On/Off.	
Auto-Power Frequency	Sets the Auto-Power On / Off Frequency.	Mon to Fri.
Reset	Resets all settings to their factory default state	Off

SETUP MENU

Photo Setup

Item	Instruction	Default setting
Display Mode	Sets the photo display mode for entering the Photo Mode from the Main Menu.	Slideshow
Display Ratio	Sets the photo display ratio.	Fit to Screen
Slideshow Duration	Sets the time interval of slideshow photos.	5Sec.
Slideshow Effect	Sets the photo slideshow effect.	Random
Slideshow Repeat	Sets the photo slideshow repeat function on/off	On

Calendar Setup

Item	Instruction	Default setting
Display Mode	Sets the Calendar display mode	Calendar+ Time+Slideshow
Date	To set Date: Press the UP / DOWN button to select the number of the date and year, and press the LEFT/RIGHT button to adjust.	
Clock Mode	Sets the Clock Mode	12-Hour
Clock Time	To set the Clock Time: Press the UP / DOWN button to select the the time, and press the LEFT/RIGHT button to select the desired time.	
Alarm Time	To set an Alarm Time: Press the UP / DOWN button to select the Off/On and time and press the LEFT/RIGHT button to select the desired time and On. To delay the alarm timer, when the alarm timer sounds, press the ENTER button to turn it off completely, press any other buttons to delay it. The alarm timer will sound again 9 minutes, 18 mintues and 27 minutes later. The alarm will then turn off automatically.	
Alarm Frequency	Sets the Alarm Frequency	Mon to Fri.
Alarm Tone	Sets the Alarm Tone	Alarm 1
Snooze	Sets Snooze Mode	Once

SETUP MENU

Video Setup

Item	Instruction	Default setting
Display Ratio	Sets the Video display ratio.	Fit to Screen
Play Mode	Sets the Video Playback Mode.	Repeat

Music Setup

Item	Instruction	Default setting
Play Mode	Sets the music playback mode.	Repeat

CONNECTION

Headphones

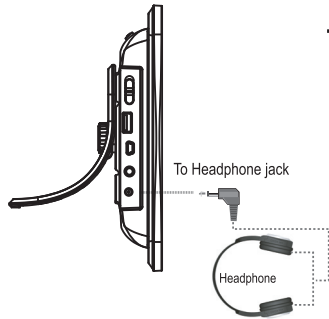

- Be sure that your unit is at low volume level before connecting the headphone.
- Increase the volume gradually to a comfortable listening level.

CAUTION:

Hearing experts advise against the constant use of personal stereos played at high volume. Constant high volume use can lead to hearing loss. If you experience ringing in the ears or hearing loss, discontinue use and seek medical advice.

KICKSTAND

Using the Kickstand

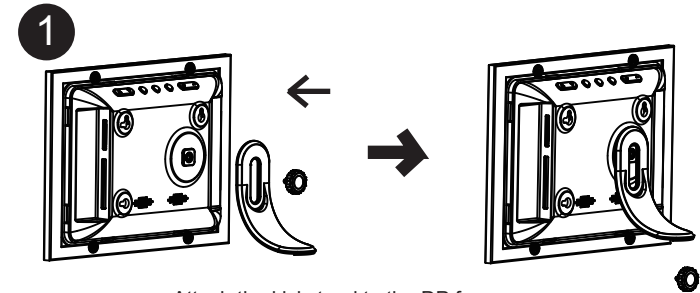

Attach the kickstand to the DP frame.

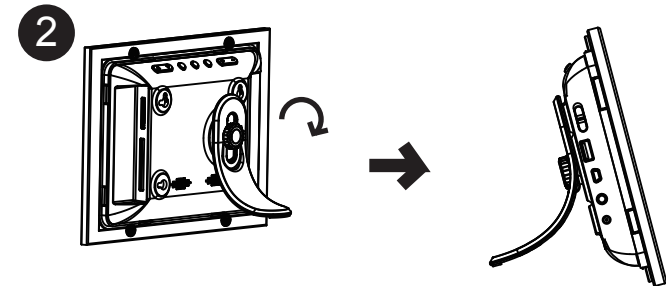

Turn the screw to the right to tighten the kickstand.

TROUBLESHOOTING

The player will not play my music file.

- Ensure that the file is in a compatible format (MP3,WMA, OGG, ADPCM-WAV or PCM-WAV).
- The file may be copy-protected. This player cannot play copy-protected files.

The player will not play my video file.

- Ensure that the video file will play on your computer using Windows Media Player 10. If the file works on the computer, use the same computer to convert the video to a compatible format.

There is no sound.

- Ensure that the volume level of the DP frame has been set to a reasonable level by the remote control or the volume buttons on the top panel of the DP frame.

The remote control does not work.

- Make sure the unit has been powered on manually (i.e., the Power Switch has been physically set to the ON position).
- Remove any obstacles between the remote control and the frame.
- Point the remote control towards the remote sensor on the frame.
- Ensure that the battery has been installed correctly in the remote control.
- Replace the battery.

The alarm does not work.

- Make sure the Alarm Setting is set properly in Calendar Setup in Setup Menu.
- Make sure the volume is set to a comfortable listening level by the remote control or the volume buttons on the top panel of the DP frame.

The photo frame has malfunctioned.

- Turn the photo frame off and let it rest for 30 minutes. After that, turn on the photo frame -- the restore function should reset the photo frame.
- Try updating the player's firmware. Please refer to the Firmware Upgrade section of this manual for detailed instructions.

SPECIFICATIONS

Display Type	8" Full-Color TFT LCD
Display Resolution	800 (H) x 600 (V)
Memory	MS Card Slot CF Card Slot SD/MMC Card Slot xD Card Slot Full-size USB port
Audio Format Support	WMA (5 ~ 384kbps 8~48KHz) MP3 (8 ~ 320kbps 8~48KHz) OGG (64~ 320kbps 8~48KHz) ADPCM-WAV (32 ~ 384kbps 8~48KHz) PCM-WAV (128 ~ 1536kbps 8~48KHz)
Video Format Support	MPEG-4, MJPEG, H264
Photo Format Support	JPEG, BMP, JPG
USB Host	USB 2.0 High-Speed
Audio Output	3.5mm Stereo / Headphone Built-in Speaker
Power Supply	DC 9V, 1A 100-240V AC Adapter
Rechargeable Built-in lithium battery	Supply battery for the clock for about 100 hours after each fully charged.
Calendar	From 1900~ 2099 years.

Specifications and manual are subject to change without prior notice.

907-DP86-0000-00R